

本企业通过ISO9001
质量管理体系认证
The company meets the ISO9001 Standard

Joyoung

使用说明书

Operation Instruction

九阳智能炒菜机

Joyoung intelligent automatic cooker

CJ-A9

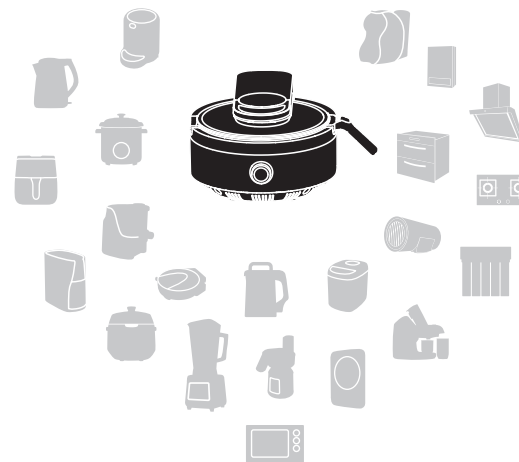

进口商Impoter :Columbia Trading Corp
制造商Manufacturer: Joyoung Company Limited
Toll Free Number: 1-888-968-8898

V20-1

使用产品前请仔细阅读本使用说明书，并妥善保管
Please carefully read the Operation Manual before
use and keep it well

产品特点

产品简介

本炒菜机适用于家庭烹饪，具体使用方法请参见使用说明。

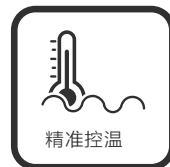

特别说明

- 1、本说明书上所有内容均经过认真核对，如有任何印刷错漏或内容上的误解，可向本公司咨询。
- 2、产品如有更新，恕不另行通知。

尊敬的用户:

感谢您使用九阳炒菜机。为了使您正确地使用和维护本机,请在使用前仔细阅读说明书,并请妥善保存,以便日后查阅。

本说明书适用于该型号炒菜机。书中所有内容仅供用户使用和维护时参考,具体以实物为准。如果您在使用上仍有问题,请向当地九阳售后服务中心或本公司客服中心咨询。

产品注意事项

为了保证安全,避免对您和他人造成伤害和财产损失,请务必遵守以下安全事项,不遵守安全警告而错误使用可能导致事故的发生,请务必遵守。

⊘ 绝对禁止操作项 ⚠ 必须遵循操作项 Ⓜ 日常注意操作项

1. 请放置于儿童不能触及的地方,禁止儿童单独操作,以免触电、烫伤或造成其他伤害。
2. 禁止在产品内部或缝隙中插入金属屑、铁丝、针等异物,否则会引起触电或工作异常。
- ⚠ 3. 在清洗、产品出现故障或不使用时,为防止漏电或意外启动,请务必拔掉电源插头。
4. 请勿将本产品直接放在火上或任何靠近热源、火源的地方,否则产品会受到损坏或发生故障,甚至发生危险。
5. 请不要将本产品放在不平稳、潮湿、高温、光滑、不耐热(如塑料台布、棉布、地毯等)的台面上,以免触电、起火、脱落等造成伤害事故和财产损失。
- Ⓜ 6. 请单独使用额定电流为10A及以上,交流电压为120V的电源插座,以免引起火灾、触电等事故。
7. 不可用湿手插、拔插头,以免触电。拔下插头时,必须握住插头柄,不能拉扯电源线,否则易损伤电源线。
8. 如果电源线损坏,为了避免危险,必须由制造商、其维修部或类似的专业人员更换。
9. 使用前,必须确保电源线与插座连接可靠,否则会因接触不良导致器件损坏,引发短路或火灾等危险。

10. 本产品为I类器具,插座接地线需保持良好接地。
11. 本产品仅作为家庭使用。任何商业用途、不适当用途或未遵守本说明书使用引发的事故或伤害本公司均不负任何责任。
12. 本产品仅供在室内使用,不可在潮湿的地方和户外使用,以防触电和器件老化造成损害事故。
13. 工作过程中,请勿搬移产品。
14. 本产品不适用下列人士:感官或心理功能障碍者、缺乏相关经验或知识者(包括儿童)等人群使用。除非他们在专业人士的监督和指导下使用本产品。应照顾好儿童,确保他们不玩耍本产品。
15. 在产品工作时会产生高温和蒸汽,请勿靠近排气孔,以防烫伤。
16. 产品发生故障请送九阳售后服务部维修,切勿自行拆卸产品或更换配件,以免引起火灾,触电或受伤。
17. 打开包装后,请即刻将塑料袋放入垃圾桶,以免儿童玩耍,造成窒息的危险。
18. 内胆切勿碰撞或直接放在其它热源上加热,例如煤气炉,否则容易变形。
19. 装有心脏起搏器的人士或助听器、植入耳蜗的使用者在使用本产品时,请咨询授权医疗人员并参考医疗设备提供的说明。
20. 本品禁止进水、用水冲洗和浸泡,以免发生触电或短路。
21. 打开包装后,请即刻将塑料袋放入垃圾桶,以免儿童玩耍,造成窒息的危险。
22. 不要将任何袋装、罐装或瓶装物品放入本产品内加热,否则有爆炸的危险。
23. 本品为自动炒菜机,不要使用带有尖锐棱角的器具(如钢丝球等)铲或清洗内胆,以免损坏内胆涂层造成糊锅。
24. 该产品可以进行炒菜、炖、煮等功能,如用该产品进行炒干货等规定以外的其他用途,可能会破坏内胆涂层或损坏元器件。
25. 在产品工作时,请勿覆盖煲盖,以防蒸汽无法排出及机体无法散热造成器件损坏。
26. 内胆底部和边缘应保持干净、胆底与发热盘表面不能附油污、饭粒等杂物。
27. 烹饪结束将食物倒出时,请确保手指不要碰到内胆,防止烫伤。
28. 严禁使用非本产品自带的内胆,以防造成元器件损坏。
29. 内胆为空的时候,请勿启动操作,以免造成元器件损坏。

部件说明

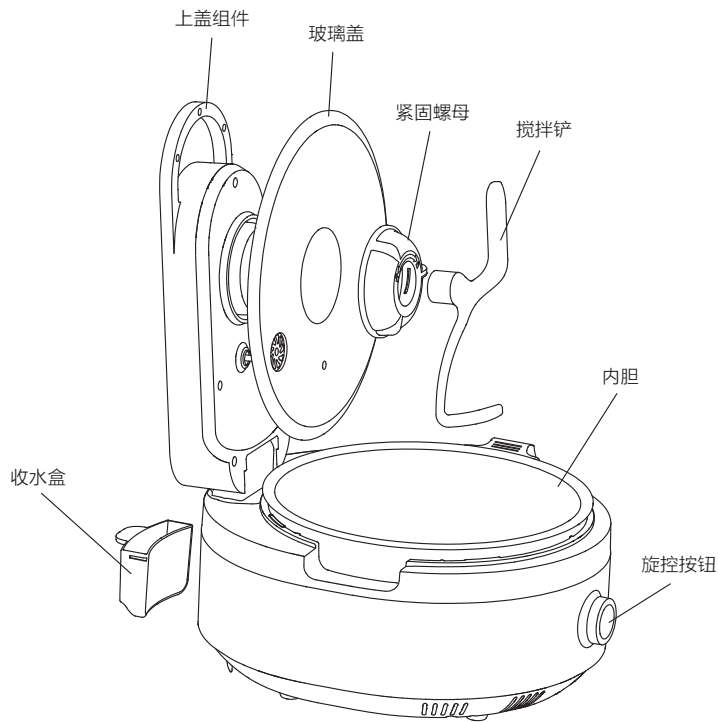

备注：图片仅供参考，具体以实物为准

操作面板

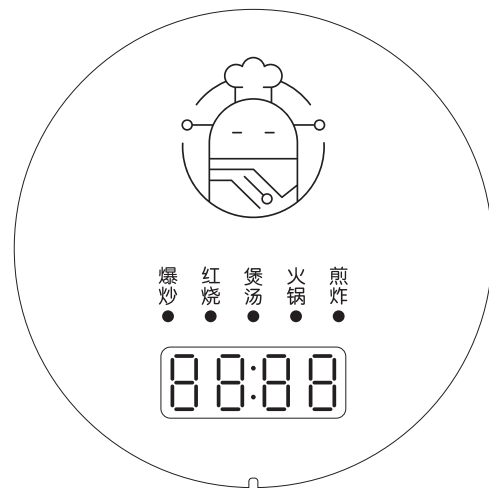

操作步骤

- 1、机器接通电源，机器鸣叫 1 秒，同时五个指示灯和数码管全亮，然后模式指示灯全灭进入待机状态。
- 2、待机状态下顺时针或逆时针旋转旋钮，可进入功能选择状态，选中功能后，对应的模式指示灯闪烁。
 - 2.1 选中爆炒功能，其对应的指示灯常亮后，旋转旋控按钮可进行时间调节，选定时间后再按下旋控按钮即可进入预热阶段，预热阶段结束后自动进入倒计时烹饪阶段。
 - 2.2 选中红烧或煲汤功能，其对应的指示灯常亮后，旋转旋控按钮可进行时间调节，选定时间后再按下旋控按钮即可进入烹饪模式。
 - 2.3 选中火锅功能，其对应的指示灯常亮后，旋转旋控按钮可进行时间调节，选定时间后再按下旋控按钮即可进入烹饪模式，进入烹饪模式后再次旋转旋控按钮可以进行火力调节。
 - 2.4 选中煎炸功能，其对应的指示灯常亮后，旋转旋控按钮可进行时间调节，选定时间后再按下旋控按钮即可进入烹饪模式，进入烹饪模式后再次旋转旋控按钮可以进行温度调节。

(注：煎炸功能为开盖状态下手动煎炸)

3、爆炒、红烧、煲汤、火锅、煎炸功能烹饪完成后，机器进入待机状态。

4、旋控按钮键使用：

4.1 暂停功能：机器工作中短按旋控按钮，并伴随有“滴”一声，机器暂停工作（火锅、煎炸功能在暂停状态下显示剩余工作时间），再短按恢复工作；

4.2 取消功能：机器在任何状态下，旋控按钮长按 2 秒，并伴随有“滴”一声，机器返回待机状态；

内胆安装示意图

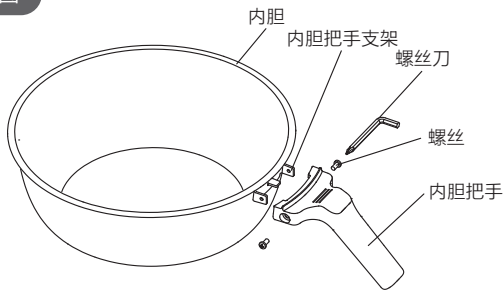

内胆安装方式

- 1、先将内胆把手按图示方向对准内胆把手支架插入到位；
- 2、用螺丝刀将螺丝拧入内胆把手上的安装孔，直到内胆把手不再松动。

产品规格表

型号	CJ-A9U
额定电压	120V
额定频率	60Hz
额定功率	1200W
额定容量	3.5L
内胆口径	260mm
产品重量	7kg
产品尺寸	428mmx247mmx393mm

故障及处理方法

	故障现象	故障原因	处理方法
1	插上电源线，指示灯不亮，蜂鸣器不叫	插头未插紧/其它原因	插紧插头/送九阳售后服务部维修
2	显示 E1,同时指示灯闪烁、蜂鸣器报警	底部传感器短路	送九阳售后服务部维修
3	显示 E2,同时指示灯闪烁、蜂鸣器报警	底部传感器开路	送九阳售后服务部维修
4	显示 E3,同时指示灯闪烁、蜂鸣器报警	干烧保护,温度过高或者锅内放置食材过少	请检查是否放置食材 / 参考食谱放入合适食材
5	显示 E4,同时指示灯闪烁、蜂鸣器报警	温度检测异常	送九阳售后服务部维修
6	显示 E5,同时指示灯闪烁、蜂鸣器报警	可控硅高温报警	请保持机器进风口通畅 / 送九阳售后服务部维修
7	显示 E6,同时指示灯闪烁、蜂鸣器报警	工作过程中开盖报警	请合上盖后再工作
8	显示 E7,同时指示灯闪烁、蜂鸣器报警	高压报警	待电压稳定后再工作 / 送九阳售后服务部维修
9	显示 E8,同时指示灯闪烁、蜂鸣器报警	低压报警	待电压稳定后再工作 / 送九阳售后服务部维修
10	显示 E9,同时指示灯闪烁、蜂鸣器报警	发热盘传感器短路	送九阳售后服务部维修
11	显示 E10,同时指示灯闪烁、蜂鸣器报警	发热盘传感器开路	送九阳售后服务部维修
12	食物出现糊锅	食材和调料放入过少	请按食谱加入适量食材
13	食物出现不熟	食材和调料放入过多	请按食谱加入适量食材
14	有异味	有塑胶味	开始使用时有塑胶味,使用一段时间后会慢慢消失

炒菜机产品的有害物质限制使用标识表

有害物质的名称和含量表

部件名称	有害物质					
	铅(Pb)	汞(Hg)	镉(Cd)	六价铬(Cr(VI))	多溴联苯(PBB)	多溴二苯醚(PBDE)
橡胶件(密封圈等)	○	○	○	○	○	○
非阻燃塑料结构件(底座、量杯等)	○	○	○	○	○	○
阻燃塑料结构件(插座等)	○	○	○	○	○	○
不锈钢结构件(转轴等)	○	○	○	○	○	○
其它金属结构件(搅拌铲等)	○	○	○	○	○	○
内胆	○	○	○	○	○	○
贴纸类(铭牌、条码等)	○	○	○	○	○	○
线束	○	○	○	○	○	○
电机	○	○	○	○	○	○
电热器(发热盘等)	○	○	○	○	○	○
玻璃盖	○	○	○	○	○	○
标准件(螺钉等)	○	○	○	×	○	○
旋控板	×	○	○	○	○	○
印刷线路板、中心盖、电源线、风扇组件(PCB板、电容、熔断器等)	×	○	○	○	○	×

○：表示该有害物质在该部件所有均质材料中的含量均在GB/T 26572规定的限量要求之下。
 ×：表示该有毒有害物质至少在该部件的某一均质材料中的含量超出GB/T 26572规定的限量要求。

“×”的部件表明，由于目前全球的技术和工艺水平限制而无法实现非环保类物质或元素的完全替代，后续随着技术上的改进将逐步改进。

电气原理图

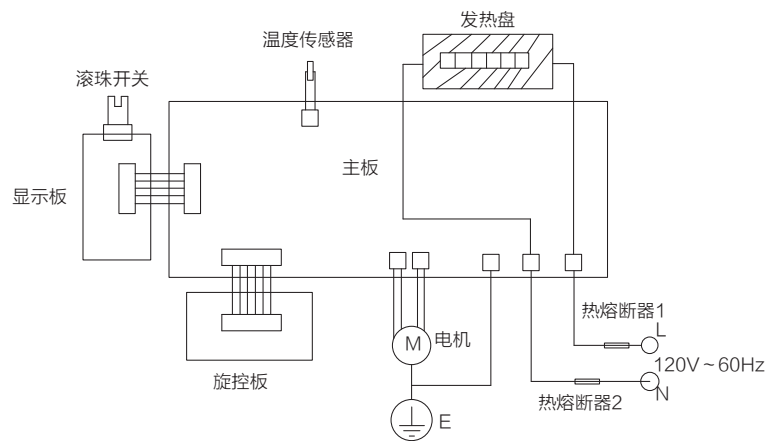

装箱明细

主机	大小勺	专用量杯(160ml)	产品说明书	螺丝	电源线	螺丝刀(L形)	内胆把手	搅拌铲	食谱
1台	各1把	1个	1本	2颗	1根	1把	1个	1个	1个

声明

本说明书中的数据由九阳研发中心数据库提供。

售后服务

服务条款

1. 本产品执行全国三包规定，整机包修1年。三包有效期自开具发票之日计算，三包范围仅限家庭使用。
2. 购机发票作为产品三包凭证。
3. 九阳用户尊享产品服务过程中的免费保洁、保养、检测服务。

非三包范围

1. 消费者因搬运、使用、维护、保管不当造成产品损坏；
2. 非我公司指定的维修点安装、维修造成损坏的（包括消费者自行安装或拆卸修理的）；
3. 无有效发票或购买证明的，且无法证明属于三包期内的；
4. 发票与实物不符或涂改的；
5. 因不可抗拒的自然灾害造成损坏的；
6. 超过三包期的；
7. 使用环境（如电压、湿度、温度、通风条件等）不符合产品说明书的表述，造成损坏的；
8. 超出九阳上门服务范围的，顾客要求必须上门的。

Product featuret

Product introduction

This automatic cooker is suitable for home cooking. Please refer to the instructions for the specific method.

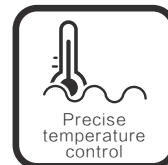

Special statement

1. All contents in this manual have been carefully checked. If there is any printing error or misunderstanding, please consult our company.
2. Products are subject to change without prior notice.



Dear users:









Thank you for using the Joyoung automatic cooker. To enable you to use and maintain the machine properly, please read the instructions carefully before use and keep them for future reference.

















This manual is applicable to this model of automatic cooker. All contents in the book are only for users for their use and maintenance reference, the specifics are subject to the material object. If you still have problems in using, please consult the local Joyoung after-sales service center or the customer service center of the company.

Precautions

In order to ensure safety and avoid injury and financial losses to you and others, please observe the following safety rules. Failure to follow safety warnings and improper use may lead to accidents, please be sure to obey.

 **Operating items absolutely prohibited**  **Operating items that must be followed**  **Operating items for daily attention**

-  1. Keep out of reach of children. Do not allow children to operate alone to avoid electric shock, burns or other injuries.
-  2. It is forbidden to insert metal chips, wire, needles or other foreign matter into the product or gaps, otherwise they will cause electric shock or abnormal working conditions.
-  3. In case of failure in cleaning or not using, be sure to pull the power plug to avoid power leak or unexpected startups.
-  4. Do not put the product directly on a source of fire or any place close to the heat source or fire source, otherwise the product may be damaged or break down, or even cause danger.
-  5. Please do not put this product on an unstable, wet, high-temperature, smooth table surface without heat resistant (such as plastic tablecloth, cotton cloth, carpet, etc.) to avoid electric shock, fire, falling off or other injury accidents and property losses.
-  6. Please use the power socket with rated current of 10A and above and alternating voltage of 120V separately to avoid fire, electric shock and other accidents.
-  7. Do not insert or pull the plug with wet hands, in order to avoid electric shock. When pulling out the plug, you must hold the plug handle and do not pull using the power cord, otherwise it may easily damage the power cord.
-  8. If the power cord is damaged, it must be replaced by the manufacturer, its maintenance department or a similar professional in order to avoid danger.
-  9. Before use, it is necessary to ensure the reliable connection between the power cord and the socket, otherwise the device will be damaged due to bad contact, resulting in short-circuit or fire hazards.

-  10. Before use, it is necessary to ensure the reliable connection between the power cord and the socket, otherwise the device will be damaged due to bad contact, resulting in short-circuit or fire hazards.
-  11. This product is for home use only. The Company shall not be liable for any accidents or injuries caused by any commercial use, improper use or non-compliance with this manual.
-  12. This product is only for indoor use, not for use in wet places or outdoors, to avoid injury and accidents caused by electric shock and aging of the device.
-  13. Do not move the product during the working process.
-  14. This product is not applicable for use by the following people: people with sensory or psychological dysfunction, people without relevant experience or knowledge (including children) and other people. They can use this product only under a professional's guidance and supervision. Take care that children are prevented from playing with this product.
-  15. High temperature and steam will be generated when the product is working. Keep away from the vent to avoid burns.
-  16. If the product breaks down, please send it to the after-sales service department of Joyoung for maintenance. Do not disassemble the product or replace the parts by yourself, which may cause fire, electric shock or injury.
-  17. After opening the package, please immediately put the plastic bags into the garbage can to prevent children from playing and running the risk of suffocation.
-  18. Do not collide with the inner container or put it directly on other heat source, such as gas stove or it will easily deform.
-  19. People with pacemakers or hearing aid or cochlear implants should consult an authorized medical practitioner and refer to the instructions provided by the medical device when using this product.
-  20. It is forbidden to wash and soak the product with water to avoid electric shock or short circuit.
-  21. After opening the package, please immediately put the plastic bags into the garbage can to prevent children from playing and running the risk of suffocation.
-  22. Do not put any bags, cans or bottles into this product to heat, otherwise there is a risk of explosion.
-  23. This product is an automatic cooker. Do not use tools with sharp edges and corners (such as steel ball, etc.) to shovel or clean the inner container so as not to damage the coating and stick to the pan bottom.
-  24. The product can be used for stir-frying, stewing, boiling and other functions. If the product is used for other purposes other than as prescribed, such as frying dry food, it may destroy the coating of the inner container or damage the components.
-  25. Do not cover the lid of the pot when the product is working, in case the steam cannot be discharged and the body cannot dissipate heat, which may cause damage to the device.
-  26. The bottom and edge of the inner container shall be kept clean, and the surface of the inner container and the heating plate shall not contain oil, rice grains or other things.

27. When pouring food out at the end of cooking, make sure that your fingers do not touch the inner container to prevent burns.
28. It is strictly prohibited to use the inner container that does not come with this product to prevent components from being damaged.
29. When the inner container is empty, do not start operations to avoid damaging the components.

Product introduction | The product shall be subject to material object

Information of parts

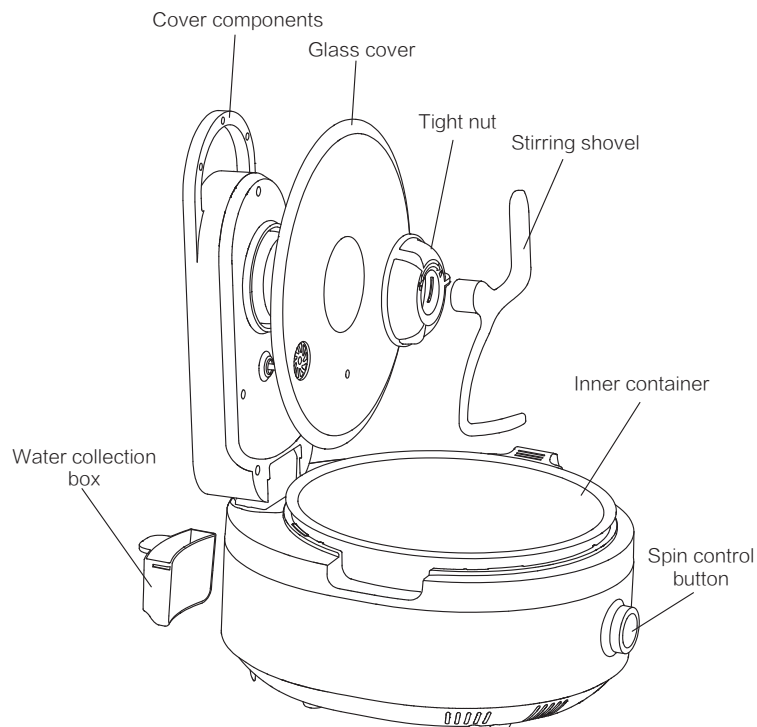

Note: The picture is for reference only, the specific product is subject to the material object

Operating panel

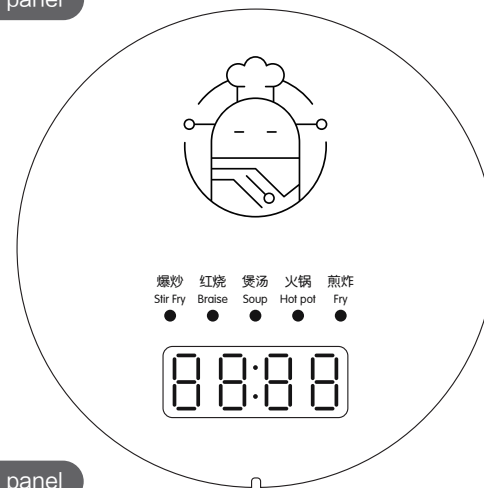

Operating panel

1. When the machine is powered on, the machine will sound for 1 second. The five indicators and the digital tube will all be on at the same time, and then the mode indicators will all be off and enter the standby state.
2. Rotate the knob clockwise or counterclockwise in standby mode to enter the function selection state. When the function is selected, the corresponding mode indicator light will flash.
 - 2.1 When selecting the stir-fry function and the corresponding indicator light is on, the rotary control button can adjust the time. After the time is selected, press the rotary control button to enter the pre-heating stage. Automatically enter the countdown cooking stage after the end of the pre-heating stage.
 - 2.2 Select the function of braising or soup. After the indicator light is on, the rotary control button can adjust the time. Press the rotary control button after the time is selected to enter the cooking mode.
 - 2.3 Select the hotpot function. After the corresponding indicator light is on, the rotary control button can adjust the time. Press the rotary control button after selecting time to enter the cooking mode and rotate the rotary control button again to adjust heat power after entering the fire control mode.
 - 2.4 Select the frying function and when the corresponding indicator light is on, rotate the rotary control button to adjust the time. Press the rotary control button after selecting the time to enter the cooking mode and rotate the rotary control button again after entering the cooking mode to adjust the temperature. (The frying function is manual frying with the lid open)

3. After the completion of stir-frying, braising, soup, hotpot and frying, the machine will enter the standby state.
4. Use of rotary control button:
 - 4.1 Pause function: When the machine is working, short press the rotary control button, accompanied by a "click," sound of the machine is paused (the hotpot and frying functions show the remaining working time in the paused state) and then press the button to resume work.
 - 4.2 Cancel function: In any state of the machine, long press the rotary control button for 2 seconds, accompanied by a "click," the machine will return to the standby state.

Schematic diagram of inner container installation

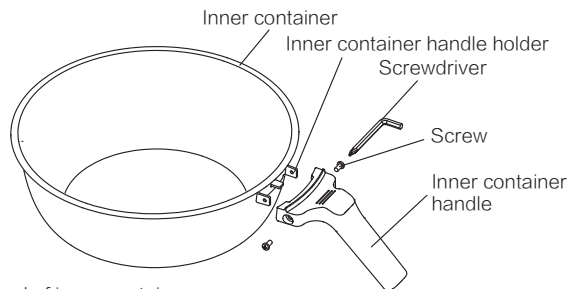

Installation method of inner container

1. First, insert the inner container handle in the direction shown in the figure into the inner container handle holder.
2. Use a screwdriver to insert the screw into the mounting hole of the inner container handle until the inner container handle is no longer loose.

Product specifications

Model	CJ-A9U
Rated voltage	120V
Rated frequency	60Hz
Rated power	1200W
Rated capacity	3.5L
Caliber of inner container	260mm
Product weight	7kg
Product size	428mmx247mmx393mm

Faults and treatments

	Fault phenomenon	Cause of failure	Treatment
1	After plugging in the power cord, the indicator light doesn't go on and the buzzer doesn't go off	The plug is not plugged in properly/other reasons	Insert the plug tightly/send it to the after-sales service department of Joyoung for maintenance
2	DisplayE1 and the indicator light flashes and the buzzer sounds an alarm	The bottom sensor gets short-circuited	Send it to Joyoung's after-sales service department for maintenance
3	DisplayE2 and the indicator light flashes and the buzzer sounds an alarm	The bottom sensor is open-circuited	Send it to Joyoung's after-sales service department for maintenance
4	DisplayE3 and the indicator light flashes and the buzzer sounds an alarm	Dry heat protection, too high temperature or too little food in the pan	Please check whether or not the food ingredients are placed/refer to the recipe to place proper ingredients
5	DisplayE4 and the indicator light flashes and the buzzer sounds an alarm	Temperature measurement is abnormal	Send it to Joyoung's after-sales service department for maintenance
6	DisplayE5 and the indicator light flashes and the buzzer sounds an alarm	Silicon-controlled high temperature alarm	Please keep the air inlet of the machine open/send it to the after-sales service department of Joyoung for maintenance
7	DisplayE6 and the indicator light flashes and the buzzer sounds an alarm	Give an alarm when opening the cover during operation	Please close the cover before starting operations
8	DisplayE7, the indicator light flashes and the buzzer sounds an alarm	High pressure alarm	Work after voltage stability/send it to Joyoung after-sales service department for maintenance
9	DisplayE8 and the indicator light flashes and the buzzer sounds an alarm	Low voltage alarm	Work after voltage stability/send it to Joyoung after-sales service department for maintenance
10	DisplayE9 and the indicator light flashes and the buzzer sounds an alarm	Short circuit of heating plate sensor	Send it to Joyoung's after-sales service department for maintenance
11	DisplayE10, the indicator light flashes and the buzzer sounds an alarm	The heating plate sensor is open-circuited	Send it to Joyoung's after-sales service department for maintenance
12	Food gets burnt	Too few food ingredients and seasonings	Please add appropriate food ingredients according to the recipe
13	The food is not cooked	Too many food ingredients and seasonings	Please add appropriate food ingredients according to the recipe

	Fault phenomenon	Cause of failure	Treatment
14	Smell something bad	There' s a plastic smell	It has a plastic smell at the beginning, which will gradually disappear after a period of time

The identification table for the limited use of hazardous substances in automatic cooker products

The name and content table of hazardous substances

Name of parts	Hazardous substance					
	Pb	Hg	Cd	Cr(VI)	PBB	PBDE
Rubber parts (sealing rings, etc.)	○	○	○	○	○	○
Non-flame retardant plastic structural parts (base, cup, etc.)	○	○	○	○	○	○
Flame retardant plastic structural parts (sockets, etc.)	○	○	○	○	○	○
Stainless steel structural parts (rotating shaft, etc.)	○	○	○	○	○	○
Other metal structural parts (WT, etc.)	○	○	○	○	○	○
Inner container	○	○	○	○	○	○
Stickers (nameplate, bar code, etc.)	○	○	○	○	○	○
Wiring harness	○	○	○	○	○	○
Motor	○	○	○	○	○	○
Electric heater (heating plate, etc.)	○	○	○	○	○	○
Glass cover	○	○	○	○	○	○
Standard parts (screws, etc.)	○	○	○	×	○	○
Touch panel	×	○	○	○	○	○
Printed circuit board, central cover, power cord, fan assembly (PCB panel, capacitance, fuse protector, etc.)	×	○	○	○	○	×

○ : Means the harmful material is within the standard.

× : Means it' s out of the standard.

Electrical schematic diagram

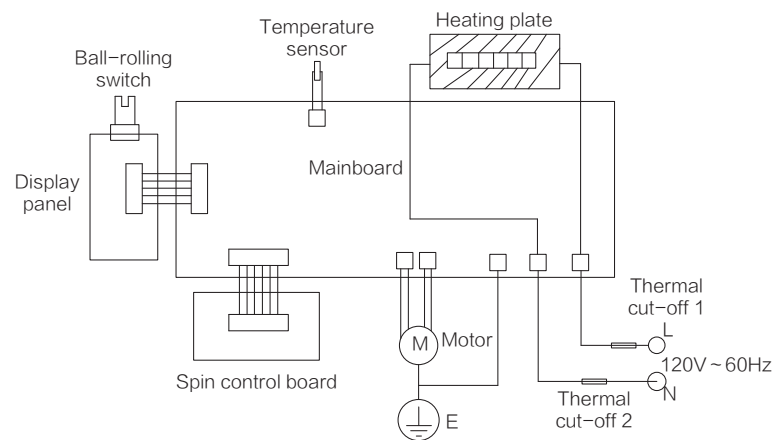

Packing details

Main machine	Big and small spoons	Special measuring cup (160ml)	Product specifications	Screw	Power line
1	1	1	1	2	1

Screwdriver (L-shaped)	Inner container handle	Stirring shovel	Recipe
1	1	1	1

Statement

The data in this manual is provided by the database of Joyoung R&D Center.

After sale service

Terms of Service

1. This product enjoys the rule: Free maintain for one year; Valid from the date of purchase;
2. This product only for home use;
3. Purchase invoices act as warranty card;

Non-Three Guarantees

1. Damages caused by consumers, like "Violent transportation" , "using" and Improper safekeeping;
2. Damages caused by Improper installation or assembly and not in Joyoung after sale service point.
3. With invalid invoice, purchase certification or beyond the Free Maintain;
4. Invoice is not conformity with the product;
5. Damages caused by nature disaster;
6. Beyond warranty;
7. Damaged caused by using in improper environment (voltage, humidity, temperature, ventilation) , which are not conform to Joyoung instruction book;
8. Outside the door-to-door service, and the customer are not willing to send it to Joyoung service point;